

inVue®

smartlock

2019 PRODUCT CATALOG



Table of Contents

OneKey Ecosystem	4
IR3 Key	5
IR Key Programming Station	6
Access Manager	7
Key Authorization Station	8
Quick Reference Guide	9
L410	12
L430	13
L440	14
Universal Lock	15
Universal Lock II	16
Plunger Lock	17
Cam Lock	18
Showcase Lock	21
Drawer Lock	22

OneKey Ecosystem

ONEKEY™ ECOSYSTEM

The Smart Lock is part of the exclusive InVue OneKey™ Ecosystem, a storewide single key solution that improves customer service, increases sales and provides high theft protection.



OneKEY™

ecosystem



SECURITY & MERCHANDISING



MOBILE POS



SOFTWARE SOLUTIONS

IR3 Key

ONEKEY™ ECOSYSTEM GETS A POWERFUL BOOST WITH THE IR3 KEY

The IR3 Key enhances OneKey Ecosystem experience with:

- › Extended battery life and increased key lifespan
- › Integrated Micro-USB charging for a single key
- › LED visual feedback for key authorization, battery life and programming time out
- › Enables InVue Access Manager
- › Works with all InVue current and future products — factory set in IR3 mode to operate with IR Programming Station makes it backwards compatible



IR3 KEY

ORDER CODE	DESCRIPTION
AK4400	IR3 Key
AK4400-S	IR3 Sounder Key
AK400-TK	IR3 Test Key (Intended for professional installers)
AK4482	IR3 Key Cover
AK4408	IR3 Key Charger
PS515-US	Power Supply - US
PS515-EU	Power Supply - EU
PS515-UK	Power Supply - UK
PS515-AUS	Power Supply - AUS
PS515-JPN	Power Supply - JPN

▶ Programming Station

IR KEY PROGRAMMING STATION

Programs the IR3 Key with a unique code. An unlimited number of IR3 Keys can be synced with a single Programming Station. Use with IR2 and IR3 Keys.



IR KEY PROGRAMMING STATION - FOR BOTH IR2 & IR3 KEYS

ORDER CODE	DESCRIPTION
PK4401	Key Programming Station

POWER SUPPLY - FOR IR PROGRAMMING STATION

ORDER CODE	DESCRIPTION
PS5VMU-US	5.3 Volt Power Supply - IR2 Programming Station - US
PS5VMU-UK	5.3 Volt Power Supply - IR2 Programming Station - UK
PS5VMU-EU	5.3 Volt Power Supply - IR2 Programming Station - EU
PS5VMU-AUS	5.3 Volt Power Supply - IR2 Programming Station - AUS
PS5VMU-ARG	5.3 Volt Power Supply - IR2 Programming Station - ARG

Access Manager

ACCESS MANAGER SOFTWARE

Access Manager software helps increase retailers' profits by reducing internal theft. The cloud based enterprise system logs OneKEY™ device interactions, making it easy to detect associate activity that is suspicious with access anytime and anywhere. Using an intuitive user interface, individual associates are enabled with access to the entire store, a department or individual InVue device.

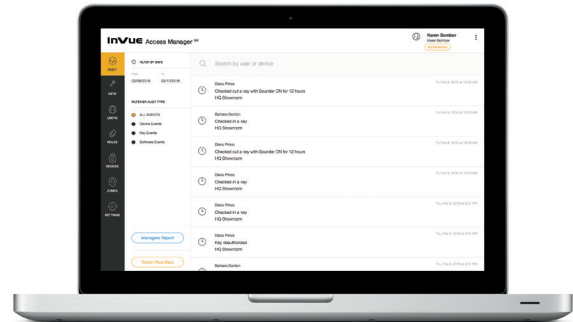

PROFITABILITY

- › Decreases internal theft, which will increase store revenues, and raise store profits

AUDITING & ZONING

- › Control employee access, set department zones, and collect key data to view team members activity

REDUCE INTERNAL THEFT

- › View what display devices and merchandise are being accessed and by whom

INCREASE STORE REVENUE

- › OneKEY access reduces customer wait times, increase associates time to sell and assist more customers

KEY BENEFITS

Cloud Based Data

- › Data can be accessed anywhere, anytime
- › Historical data can be accessed easily over time

System Hierarchy

- › Segment employee interactions by headquarters, division or individual store
- › Updates can be made easily to the hierarchy

Store Format(s) Naming

- › All zones and devices are named consistently across the estate
- › Predetermined zones are defined for specific store formats

Single Sign On

- › Access Manager permissions at HQ and store
- › Automatic role assignment at HQ

Key Authorization Station

KAS

The Key Authorization Station works through Access Manager to help reduce internal theft by logging every InVue device for every associate:

- › Each associate is tracked by their own unique check-out codes
- › Keys will record times for checking-in/out keys, where the keys were used and how long displays were open
- › Logged information will be stored in Access Manager for easy access and report generation



ACCESS MANAGER

Please contact your InVue representative for Access Manager license pricing and order entry information.

KEY AUTHORIZATION STATION	
ORDER CODE	DESCRIPTION
AK4401	Key Authorization Station
AK4484	InVue Set-up Cable
DNPZ11W	Ethernet Cable
PS512-US	Key Authorization Station Power Supply

Quick Reference Guide

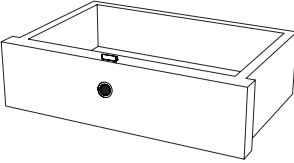
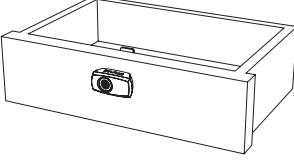
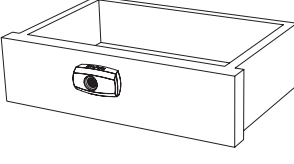
PULL-OUT DRAWER		
FIXTURE STYLE	SMART LOCK COMPATIBILITY	ACCESSORIES
Wood 	L430 Lock (PL701, PL702) 19mm-31mm drawer wall thickness <i>Note: Recessed or non-recessed installation into new or existing 22mm hole. Mounting hardware and rounded strike plate included. If mounting into existing 28mm hole, PL743 is required.</i>	Flat Strike Plate (PL720-2) Trim Ring (PL741) Bumper (PL742) Adapter Assembly Kit for PL702 (PL743)
Wood 	Drawer Lock (PL501, PL70, L430, LPL701, PL702) 20mm-30mm drawer wall thickness Drawer Arms (PL520 series): 5 different Drawer Arms <i>Note: Two-piece lock installs into existing 22mm hole. Mounting hardware is included. Drawer Arm selection required prior to order: reference 2D drawing, product catalog or Drawer Arm sizing kit.</i>	None
Glass, Wood, Metal (or a combination of two) 	Cam Lock (PL302) 10mm-19mm drawer wall thickness Cam Arms (PL320 series): 31 different Cam Arms <i>Note: Simple installation into existing 19mm hole. Mounting hardware is included. Cam Arm selection required prior to order: reference 2D drawing, product catalog or Cam Arm sizing kit.</i>	Flat Bracket (PL322 series) L Bracket (PL323 series)

Quick Reference Guide

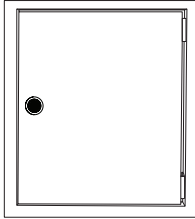
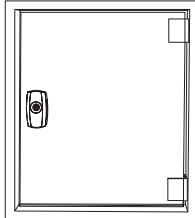
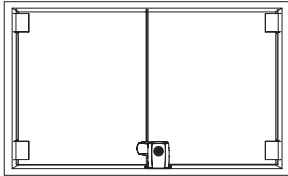
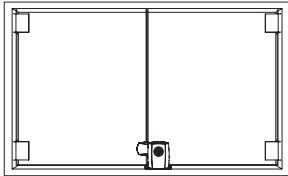
SWING OUT DRAWER		
FIXTURE STYLE	SMART LOCK COMPATIBILITY	ACCESSORIES
<p>Wood</p> 	<p>L430 Lock (PL701, PL702) 19mm-31mm drawer wall thickness</p> <p><i>Note: Recessed or non-recessed installation into new or existing 22mm hole. Mounting hardware and rounded strike plate included. If mounting into existing 28mm hole, PL743 is required.</i></p>	<p>Flat Strike Plate (PL720-2)</p> <p>Trim Ring (PL741)</p> <p>Bumper (PL742)</p> <p>Adapter Assembly Kit for PL702 (PL743)</p>
<p>Glass, Wood, Metal (or a combination of two)</p> 	<p>Cam Lock (PL302, PL70, L430, LPL701, PL702) Glass: Minimum 6mm panel thickness Wood or Metal: 10mm-19mm drawer wall thickness</p> <p>Cam Arms (PL320 series): 31 different Cam Arms</p> <p><i>Note: Mounting hardware is included. Cam Arm selection required prior to order: reference 2D drawing, product catalog or Cam Arm sizing kit.</i></p>	<p>Flat Bracket (PL322 series)</p> <p>L Bracket (PL323 series)</p> <p>Glass Mounting Kit (PL321-1) <i>Required only when mounting directly to glass</i></p>
<p>Glass with a Wood Frame</p> 	<p>Showcase Lock (PL401) 6mm panel thickness</p> <p><i>Note: Mounting hardware must attach to wood structures. Mounting hardware template provided. Minimal drilling is required. PSA installation of lock.</i></p>	<p>Brace Kit for Second Door (PL420-01)</p> <p>Lock Shim (PL441)</p>
<p>Glass with a Wood Frame or Glass Frame</p> 	<p>L440 Lock (PL401) 4.5mm-8mm door thickness</p> <p><i>Note: Mounting hardware must attach to wood structures. Mounting hardware template provided. Minimal drilling is required. PSA installation of lock.</i></p>	<p>Brace Kit for Second Door (PL420-01)</p> <p>Lock Shim (PL441)</p>

Quick Reference Guide

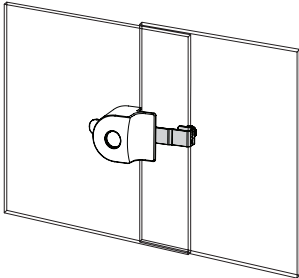
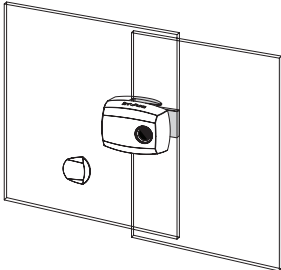
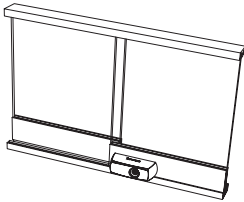
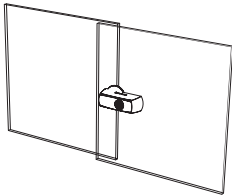
SLIDING BYPASS DRAWER		
FIXTURE STYLE	SMART LOCK COMPATIBILITY	ACCESSORIES
Glass (no holes; no frames) 	L410 (PL801) <i>4.8mm-8mm panel thickness</i> <i>4.5mm-11.5mm panel gap</i> Short Strike Plate (PL820-11) <i>22mm-65mm panel overlap</i> Long Strike Plate (PL820-21) <i>65mm-110mm panel overlap</i>	Short Strike Plate (PL820-11) Long Strike Plate (PL820-21)
<i>Note: PSA installation — no drilling or screws required</i>		
Glass (no holes; no frames) 	Universal Lock (PL106) <i>5.8mm-6.35mm panel thickness</i> Universal Lock II (PL103) <i>4.8mm-6.35mm panel thickness</i> Strike Plate (Universal: PL120 series; Universal II: PL123 series) Strike Plate Shim (Universal: PL143 series; Universal II: PL145 series)	Lock Shim* (PL144 for Universal II) <i>*Not an option for Universal Lock</i>
<i>Note: PSA installation — no drilling or screws required</i>		
Glass with a Metal Frame; Wood 	Plunger Lock II (PL202)	None
<i>Note: Simple installation into existing 22mm hole. Mounting bracket and four screws included. Plunger extender option included in mounting hardware.</i>		
Glass with Existing Hole 	Plunger Lock III (PL203)	None
<i>Note: Simple installation into existing 22mm-32mm hole. Mounting bracket and four screws included. Plunger extender option included in mounting hardware.</i>		

▶ **L410**

L410

Self-locking protection for sliding bypass doors.

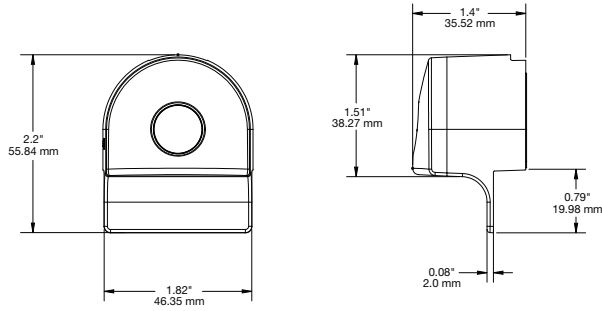

L410



ORDER CODE DESCRIPTION

PL801 L410

STRIKE PLATE - REQUIRED



ORDER CODE DESCRIPTION

PL820-11 L410 Strike Plate, Wide Attachment (22mm-65mm)
for panel overlaps 22mm-65mm



PL820-21 L410 Strike Plate, Wide Attachment (65mm-110mm)
for panel overlaps 65mm-110mm

ACCESSORIES



ORDER CODE DESCRIPTION

PL842 L410 Replacement Cover - 5 pack

L430

L430

Designed as a self-latching lock that can be embedded in furniture.

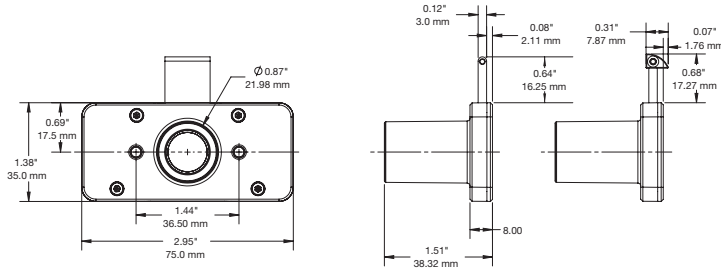

L430



ORDER CODE	DESCRIPTION
PL701	L430 — Long Latch
PL702L	L430 — Short Latch

OTHER PARTS



ORDER CODE	DESCRIPTION
PL720-2	L430 Flat Strike Plate - 5 pack <i>for installations that require there to be no visible latch ramp when cabinet or drawer is closed</i>
PL741	L430 Trim Ring - 5 pack <i>used to conceal any gap that may exist when replacing a 28mm diameter lock with the L430</i>
PL742	L430 Bumper - 5 pack <i>provides protection to both the L430 and furniture in cases where the cabinet may swing open and make contact with other surfaces</i> <i>features a rubber tip and chrome finish</i>
PL743	PL702 Adapter Kit <i>used when replacing a 28mm lock</i>





METAL GUIDANCE

Guidance For Mounting The L430 Lock In Metal

- › Metal can interfere with the communication between InVue keys and locks. If the L430 is installed in surface that contains a metal laminate, the barrel of the lock must protrude out from the metal.

*For 1/8" thick steel, a 15mm protrusion is recommended
For 1/8" thick aluminum, a 18mm protrusion is recommended*

- › If the fixture is unable to accommodate the recommended protrusion or if the material is thicker than 1/8", please contact InVue Customer Service.

L440

L440

Self-locking protection designed to work with any glass swing out doors.

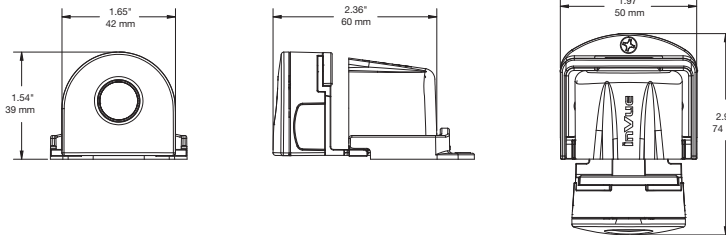

L440



ORDER CODE	DESCRIPTION
------------	-------------

PL901	L440
-------	------

KITS



ORDER CODE	DESCRIPTION
------------	-------------

PL920-01	L440 Door Brace Kit - 1 pack <i>includes: Brace, 2 Screws, Screwdriver</i>
----------	---

PL920-2	L440 Glass Mounting Kit - 1 pack <i>includes: J-Bracket, 2 Plastic Washers</i>
---------	---

PL942	L440 Replacement Adhesive Kit - 1 pack
-------	--

ACCESSORIES



ORDER CODE	DESCRIPTION
------------	-------------

PL943	L440 Glass Mount Adhesive Replacement
-------	---------------------------------------

TOOLS



ORDER CODE	DESCRIPTION
------------	-------------

PL952	L440 Sizing Tool
-------	------------------

Universal Lock

UNIVERSAL LOCK

Designed for 6mm by-pass glass doors.
For panel gap 8mm-11.5mm (0.3" - 0.5").

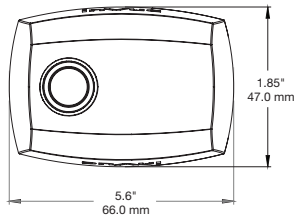
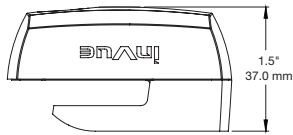



UNIVERSAL LOCK

	ORDER CODE	DESCRIPTION
	PL106-B	Universal Lock - Black
	PL106-W	Universal Lock - White

STRIKE PLATE - REQUIRED

	ORDER CODE	DESCRIPTION
	PL120-1	Strike Plate — Extra Narrow Overlap
	PL120-2	Strike Plate — Narrow Overlap
	PL120-3	Strike Plate — Standard Overlap
	PL120-4	Strike Plate — Wide Overlap
	PL120-5	Strike Plate — Extra Wide Overlap

ACCESSORIES

	ORDER CODE	DESCRIPTION
	PL142	Universal Lock Panel Handle - 5 pack
	PL143	Strike Plate Wide Gap Shim - 5 pack

TOOLS

	ORDER CODE	DESCRIPTION
	PL156	Sizing Tool

Universal Lock II

UNIVERSAL LOCK II

Designed for 6mm by-pass glass doors.

For panel gap 4.5mm-8mm (0.18" - 0.3").

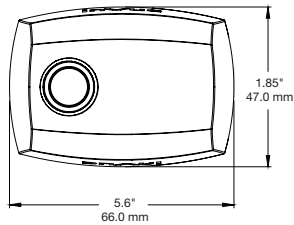
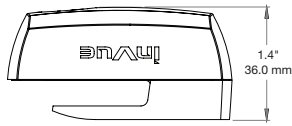

UNIVERSAL LOCK II



ORDER CODE	DESCRIPTION
PL103-B	Universal Lock II - Black
PL103-W	Universal Lock II - White

STRIKE PLATE - REQUIRED



ORDER CODE	DESCRIPTION
PL123-1	Strike Plate — Extra Narrow Overlap — Thin Gap
PL123-2	Strike Plate — Narrow Overlap — Thin Gap
PL123-3	Strike Plate — Standard Overlap — Thin Gap
PL123-4	Strike Plate — Wide Overlap — Thin Gap
PL123-5	Strike Plate — Extra Wide Overlap — Thin Gap

ACCESSORIES



ORDER CODE	DESCRIPTION
PL142	Universal Lock Panel Handle - 5 pack
PL144	PL103 Shim - 5 pack
PL145	Strike Plate Wide Gap Shim - 5 pack

TOOLS



ORDER CODE	DESCRIPTION
PL153	PL103 Sizing Tool

Plunger Lock

PLUNGER LOCK II

Designed for bypass metal framed glass doors and bypass wood doors.

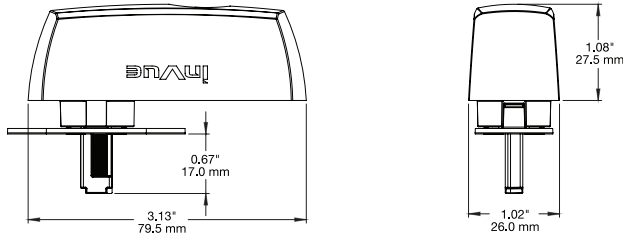

PLUNGER LOCK II



ORDER CODE

DESCRIPTION

PL202-B

Plunger Lock II (22mm, 0.87" panel hole) - Black

PL202-W

Plunger Lock II (22mm, 0.87" panel hole) - White

PLUNGER LOCK III

Designed for glass bypass doors with pre-drilled holes.

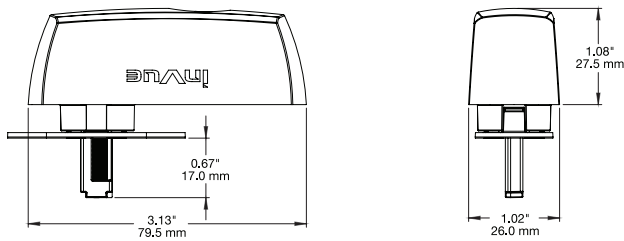

PLUNGER LOCK III



ORDER CODE

DESCRIPTION

PL203-B

Plunger Lock III (22mm-32mm, 0.87"-1.26" panel hole) - Black

PL203-W

Plunger Lock III (22mm-32mm, 0.87"-1.26" panel hole) - White

ACCESSORIES



ORDER CODE

DESCRIPTION

PL241-B

Spacer (3.18mm, 0.125") - Black

PL241-W

Spacer (3.18mm, 0.125") - White
works with the PL202 and the PL203



PL251

Extender Kit (19mm, 0.75")
works with the PL202 and the PL203

Cam Lock

CAM LOCK

Designed for swing-out or pull-out doors and drawers.

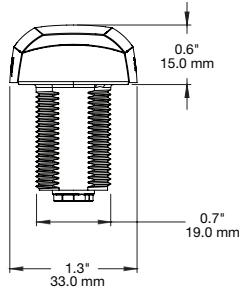
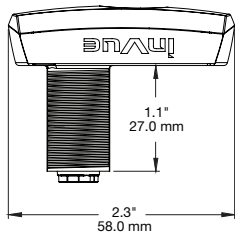

CAM LOCK



ORDER CODE

DESCRIPTION

PL302-B

Cam Lock 90 degree (19mm, 0.75" panel hole) - Black

PL302-W

Cam Lock 90 degree (19mm, 0.75" panel hole) - White

CAM LOCK ACCESSORIES

Two Cam arm styles are available: Straight and Offset.

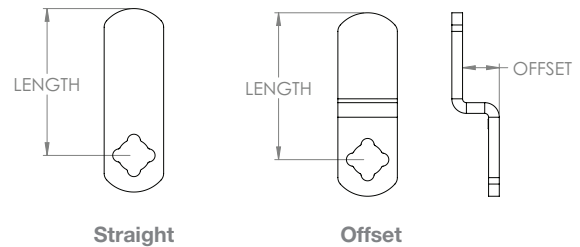

Note: Arm length is measured from the center of the hole.

ARM STYLE: STRAIGHT - REQUIRED FOR INSTALLATION



ORDER CODE

DESCRIPTION

PL320-101

Cam Arm Straight (16mm, 0.63") - 5 pack

PL320-102*

Cam Arm Straight (19mm, 0.75") - 5 pack

PL320-103*

Cam Arm Straight (22mm, 0.88") - 5 pack

PL320-104*

Cam Arm Straight (25mm, 1.00") - 5 pack

PL320-105*

Cam Arm Straight (28mm, 1.13") - 5 pack

PL320-106

Cam Arm Straight (32mm, 1.25") - 5 pack

PL320-107*

Cam Arm Straight (35mm, 1.38") - 5 pack

PL320-108*

Cam Arm Straight (38mm, 1.50") - 5 pack

PL320-110*

Cam Arm Straight (44mm, 1.75") - 5 pack

PL320-112*

Cam Arm Straight (51mm, 2.00") - 5 pack

PL320-116*

Cam Arm Straight (63mm, 2.50") - 5 pack

* Built to order items – minimum order quantities may apply

Cam Lock

CAM LOCK ACCESSORIES

Two Cam arm styles are available: Straight and Offset.

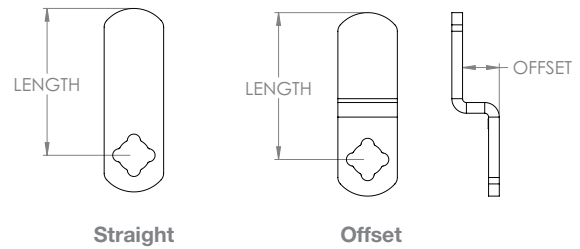

Note: Arm length is measured from the center of the hole.

ARM STYLE: OFFSET - REQUIRED FOR INSTALLATION



ORDER CODE	DESCRIPTION
PL320-303*	Cam Arm Offset (22mm x 3mm, 0.875" x 0.125") - 5 pack
PL320-306	Cam Arm Offset (32mm x 3mm, 1.25" x 0.125") - 5 pack
PL320-308*	Cam Arm Offset (38mm x 3mm, 1.50" x 0.125") - 5 pack
PL320-404*	Cam Arm Offset (25mm x 6mm, 1.00" x 0.25") - 5 pack
PL320-406	Cam Arm Offset (32mm x 6mm, 1.25" x 0.25") - 5 pack
PL320-408*	Cam Arm Offset (38mm x 6mm, 1.50" x 0.25") - 5 pack
PL320-410*	Cam Arm Offset (44mm x 6mm, 1.75" x 0.25") - 5 pack
PL320-412*	Cam Arm Offset (51mm x 6mm, 2.00" x 0.25") - 5 pack
PL320-414*	Cam Arm Offset (57mm x 6mm, 2.25" x 0.25") - 5 pack
PL320-504*	Cam Arm Offset (25mm x 10mm, 1.00" x 0.375") - 5 pack
PL320-506*	Cam Arm Offset (32mm x 10mm, 1.25" x 0.375") - 5 pack
PL320-508*	Cam Arm Offset (38mm x 10mm, 1.50" x 0.375") - 5 pack
PL320-606*	Cam Arm Offset (32mm x 12mm, 1.25" x 0.50") - 5 pack
PL320-608*	Cam Arm Offset (38mm x 12mm, 1.50" x 0.50") - 5 pack
PL320-610*	Cam Arm Offset (44mm x 12mm, 1.75" x 0.50") - 5 pack
PL320-801*	Cam Arm Offset (30mm x 25mm, 1.25" x 1.00") - 5 pack

* Built to order items – minimum order quantities may apply

KITS



ORDER CODE	DESCRIPTION
PL320-SK	Cam Arm Sizing Kit <i>includes: All Cam Arms, 1 L-Bracket, 1 Glass Mount Kit</i>
PL321-1	Glass Mounting Kit - 1 pack <i>includes: J-Bracket, 2 Plastic Washers</i>
PL321-2	Hardware Replacement - 5 pack <i>includes: Nut, Screw, Anti-Rotation Washer, Wood Mount Flange, Wood Screws</i>

Cam Lock

CAM LOCK ACCESSORIES

A latch bracket is required for proper installation.
InVue recommended brackets are listed below.

LATCH BRACKET



ORDER CODE	DESCRIPTION
PL323-02	L-Bracket (25mm x 6mm, 1" x 0.25") - 5 pack <i>includes: Bracket, Wood Screws, Metal Screws</i>
PL323-03	L-Bracket (25mm x 12mm, 1" x 0.50") - 5 pack <i>includes: Bracket, Wood Screws, Metal Screws</i>
PL323-04	L-Bracket (25mm x 19mm, 1" x 0.75") - 5 pack <i>includes: Bracket, Wood Screws, Metal Screws</i>
PL323-05	L-Bracket (50mm x 25mm, 2" x 1.00") - 5 pack <i>includes: Bracket, Wood Screws, Metal Screws</i>

TUBE ASSEMBLY



ORDER CODE	DESCRIPTION
PK4496-B	Tube Assembly - Black <i>for use when embedding Smart Locks</i>
PK4496-W	Tube Assembly - White <i>for use when embedding Smart Locks</i>

Showcase Lock

SHOWCASE LOCK

Designed for single or double sing-out glass doors.

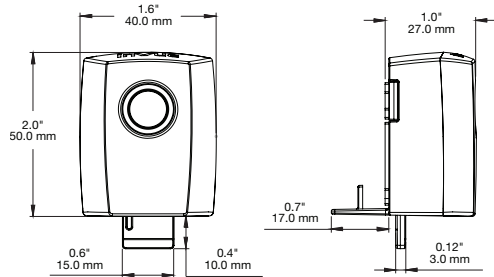

SHOWCASE LOCK



ORDER CODE

DESCRIPTION

PL401-B

Showcase Lock - Black

PL401-W

Showcase Lock - White

SHOWCASE LOCK ACCESSORIES



ORDER CODE

DESCRIPTION

PL420-01

Door Brace Accessory Kit

Drawer Lock

DRAWER LOCK

Designed for pull-out drawers.

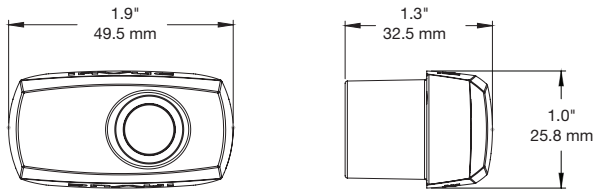

DRAWER LOCK



ORDER CODE	DESCRIPTION
PL501-B	Drawer Lock - Black
PL501-W	Drawer Lock - White

DRAWER LOCK ACCESSORIES

Two Drawer Lock arm styles are available: Straight and Offset.

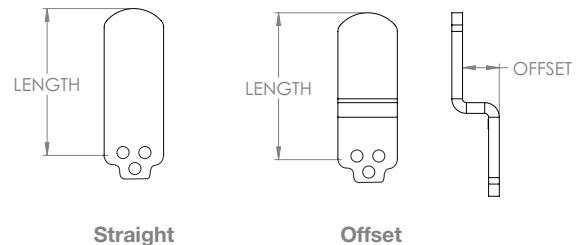

Note: Arm length is measured from the center of the hole.

ARM STYLE: STRAIGHT



ORDER CODE	DESCRIPTION
PL520-2001	Drawer Arm Straight (20mm, 0.79") - 1 pack
PL520-2002	Drawer Arm Straight (36mm, 1.42") - 1 pack
PL520-2003	Drawer Arm Straight (52mm, 2.05") - 1 pack
PL520-2004	Drawer Arm Straight (72mm, 2.83") - 1 pack

ARM STYLE: OFFSET



ORDER CODE	DESCRIPTION
PL520-2205	Drawer Arm Offset (34mm, 1.34") - 1 pack

ARM STYLE: OFFSET



ORDER CODE	DESCRIPTION
PL520-SK	Drawer Lock Sizing Kit



www.invue.com

The Americas 704.752.6513 • 888.55.INVUE
Europe, Middle East, and Africa +31.23.8900150
Asia Pacific +852.3127.6811