

# securefixtures



Includes the Award  
Winning Shelf Tether™





# Secure Fixtures

part of the IR Ecosystem™

SHELF TETHER™ ▶



◀ IR STOPLOK™



IR FLEXIBLE LOCKING HOOK™ ▶



◀ IR LOCKING HOOK™





## IR ECOSYSTEM™

Secure Fixtures is part of the exclusive InVue IR Ecosystem™, a storewide single key solution that improves customer service, increases sales and provides high theft protection.



# Shelf Tether™

*protection for merchandise on shelves*

InVue's Shelf Tether's innovative design has won awards for its product design. This is the perfect combination of security and customer experience. Customers can pick up the product and experience it, but thieves cannot steal it.



Feature	Benefit
3 feet of recoiling cable	Allows customer to interact with product
Cut resistant cable	Alarms if tampered (non-alarming also available)
Secure base unit	Alarms if taken off wall by manual attack
Works with IR2 Key	One key for a store-wide security solution

### SHELF TETHER ORDERING INFORMATION



#### SHELF TETHER

ORDER CODE	DESCRIPTION
NT1	Alarming base unit
NT2	Non-alarming base unit

#### ACCESSORIES



ORDER CODE	DESCRIPTION
NT-BRACKET-FB	American Pegboard Shelf Tether Bracket (5-Count)



NT-BRACKET-A	American Pegboard Shelf Tether Bracket (5-Count)
NT-BRACKET-E	European Pegboard Shelf Tether Bracket (5-Count)



NT-BRACKET-VL	Extended Slat Wall Shelf Tether Bracket (5-Count) <i>(For Shelf Tether placement above or below slat line)</i>
---------------	---



NT-BRACKET-PSA	Flat Surface Shelf Tether Bracket with Adhesive (5-Count)
----------------	---



NTAP-PSA	Replacement Adhesive for NT-BRACKET-PSA
----------	---



NTAP-01	Adhesive Hang Tabs (100-Count)
---------	--------------------------------

# IR StopLok™

*integrates with existing hooks and fixtures*

Display and protect merchandise on any commodity peg hook. The IR StopLok quickly and easily integrates with your store's current system. You control the amount of live and locked merchandise on display.



**Feature**

Attaches to commodity peg hooks  
 Small footprint  
 Rugged design  
 Place anywhere on wire  
 Works with IR2 Key

**Benefit**

Works with current setup  
 Maximizes merchandise branding  
 Can withstand manual attacks  
 Control amount of live and locked merchandise  
 One key for a store-wide security solution

**IR STOPLOK ORDERING INFORMATION**

<b>ORDER CODE</b>	<b>DESCRIPTION</b>
NS6A	Fits 5.0 mm Diameter Wire
NS6B	Fits 5.5 mm Diameter Wire
NS6C	Fits 6.0 mm Diameter Wire
NS8A	Fits 6.4 mm Diameter Wire
NS8B	Fits 7.0 mm Diameter Wire
NS8C	Fits 8.1 mm Diameter Wire

**Minimum Order:** 25 units per order code



# IR Flexible Locking Hook™

*provides customizable locking hook protection*

IR Flexible Locking Hooks provide flexible options to customers and sales associates. Allow customers to access one or two “live” products, but leave the rest locked behind the StopLok.



Feature	Benefit
StopLok provides flexibility	Control amount of live and locked merchandise
Signature locking back secures hook	Easy to remerchandise, but hard for thieves to steal
Integrated information tag	Showcases product information
Works with IR2 Key	One key for a store-wide security solution

**IR FLEXIBLE LOCKING HOOK ORDERING INFORMATION**

 	<b>5.5" (14 CM) SINGLE WIRE</b>	
	<b>ORDER CODE</b>	<b>WALL TYPE</b>
	NFLOK5.5	American Pegboard
 	<b>7" (18 CM) DOUBLE WIRE</b>	
	<b>ORDER CODE</b>	<b>WALL TYPE</b>
	NF2LOK7 NF2LOK7E	American Pegboard European Pegboard
 	<b>9" (23 CM) DOUBLE WIRE</b>	
	<b>ORDER CODE</b>	<b>WALL TYPE</b>
	NF2LOK9 NF2LOK9E	American Pegboard European Pegboard
	<b>OM REMOVAL TOOL</b>	
	<b>ORDER CODE</b>	<b>DESCRIPTION</b>
	OM-RT	Needed to remove locking back for re-merchandising Minimum Order Quantity: 1

Minimum Order is 25 unless otherwise stated above

# IR Locking Hook™





*high security with simplicity for store associates*

IR Locking Hooks provide the highest level of security, while still allowing customers to see the merchandise. The front lock swivels up so that sales associates can remove merchandise easily.



Feature	Benefit
All merchandise is securely locked	Minimizes the risk of theft
Front lock swivels up	Easy for associate to remove merchandise
Signature locking back secures hook	Easy to remerchandise, but hard for thieves to steal
Optional information tag	Showcases product information
Works with IR2 Key	One key for a store-wide security solution

### IR LOCKING HOOK ORDERING INFORMATION

	<b>6" (15 CM) - WITH INFORMATION TAG</b>
<b>ORDER CODE</b>	<b>WALL TYPE</b>
NL6	American Pegboard
	<b>7" (18 CM) - WITH INFORMATION TAG</b>
<b>ORDER CODE</b>	<b>WALL TYPE</b>
NL7	American Pegboard
	<b>7" (18 CM)</b>
<b>ORDER CODE</b>	<b>WALL TYPE</b>
NL7-NT	American Pegboard
	<b>7" (18 CM) - FASTBAK - WITH INFORMATION TAG</b>
<b>ORDER CODE</b>	<b>WALL TYPE</b>
NL7FB	Slatwall Adjustable Program <i>(see page 28 for FastBak™ BakPak™ spacers)</i>
	<b>7" (18 CM) - FASTBAK</b>
<b>ORDER CODE</b>	<b>WALL TYPE</b>
NL7FB-NT	Slatwall Adjustable Program <i>(see page 28 for FastBak™ BakPak™ spacers)</i>



**9" (23 CM) - WITH INFORMATION TAG**

**ORDER CODE**                      **WALL TYPE**

NL9  
NL9E                                      American Pegboard  
European Pegboard



**9" (23 CM)**

**ORDER CODE**                      **WALL TYPE**

NL9-NT                                      American Pegboard



**9" (23 CM) - FASTBAK - WITH INFORMATION TAG**

**ORDER CODE**                      **WALL TYPE**

NL9FB                                      Slatwall Adjustable Program  
*(see page 28 for FastBak™ BakPak™ spacers)*



**9" (23 CM) - FASTBAK**

**ORDER CODE**                      **WALL TYPE**

NL9FB-NT                                      Slatwall Adjustable Program  
*(see page 28 for FastBak™ BakPak™ spacers)*



**11" (15 CM) - WITH INFORMATION TAG**

**ORDER CODE**                      **WALL TYPE**

NL11    American Pegboard



**12" (18 CM) - WITH INFORMATION TAG**

**ORDER CODE**                      **WALL TYPE**

NL12    American Pegboard



**OM REMOVAL TOOL**

**ORDER CODE**                      **DESCRIPTION**

OM-RT                                      Needed to remove locking back for re-merchandising  
Minimum Order Quantity: 1

Minimum Order is 25 unless otherwise stated above

# Secure Fixtures

HELIX™ WALL DISPENSERS ▶



◀ STOPLOK™



FLEXIBLE LOCKING HOOK ▶  
- DOUBLE WIRE



◀ FLEXIBLE LOCKING HOOK  
- SINGLE WIRE



LOCKING HOOK ▶





# Helix Wall Dispenser

Prevents sweeping while providing consumers full access to merchandise. The Helix Wall Dispenser benefits both store associates and consumers. Associates can quickly load and effectively maintain a retail set. Consumers can dispense merchandise efficiently at all times.



**HELIX WALL DISPENSER ORDERING INFORMATION**



**HELIX WALL DISPENSER 9" - (STANDARD MERCHANDISE, SHORT HOOK)**

ORDER CODE	WALL TYPE
------------	-----------

SFH03-20S	American Pegboard
-----------	-------------------



**HELIX WALL DISPENSER 12" - (STANDARD MERCHANDISE)**

ORDER CODE	WALL TYPE
------------	-----------

SFH03-20	American Pegboard
----------	-------------------



**HELIX WALL DISPENSER 12" - (THIN MERCHANDISE)**

ORDER CODE	WALL TYPE
------------	-----------

SFH03-15	American Pegboard
----------	-------------------



**HELIX WALL DISPENSER 12" - (THICK MERCHANDISE)**

ORDER CODE	WALL TYPE
------------	-----------

SFH03-35	American Pegboard Hook
----------	------------------------



**HELIX WALL DISPENSER 12" - (STANDARD MERCHANDISE)**

ORDER CODE	WALL TYPE
------------	-----------

SFH03-20UW	UniWeb Wall
------------	-------------



# StopLok

StopLok adds security to non-secure hooks. Allows retailers to select the number of “live” and “locked” merchandise items.



## STOPLOK DISPENSER ORDERING INFORMATION



### OM SINGLE WIRE - 6 MM DIAMETER

ORDER CODE	WALL TYPE
------------	-----------

SL4W	Robust single wire design
------	---------------------------



### OM SINGLE WIRE - 8 MM DIAMETER

ORDER CODE	WALL TYPE
------------	-----------

SL8W	Robust single wire design
------	---------------------------

# Flexible Locking Hook – Double Wire

Flexible Locking Hooks are one of the most cost-effective and adaptable item-level security solutions available. The patented magnetic locking system provides high-level key security and allows retailers to select the number of “live” and “locked” merchandise items. Product base is engineered to lock and unlock easily for quick plan-o-gram updates.



**FLEXIBLE LOCKING HOOK ORDERING INFORMATION**

		<b>SH500 FLEXIBLE LOCKING HOOK – DOUBLE WIRE – 7” (18 MM)</b>	
		<b>ORDER CODE</b>	<b>WALL TYPE</b>
		SF2LOK05	American Pegboard Minimum quantity: 2000
		<b>SH500 FLEXIBLE LOCKING HOOK – DOUBLE WIRE – 7” (18 MM)</b>	
		<b>ORDER CODE</b>	<b>WALL TYPE</b>
		SF2LOK05E	European Pegboard
		<b>SH500 FLEXIBLE LOCKING HOOK – DOUBLE WIRE – FASTBAK™ – 7” (18 MM)</b>	
		<b>ORDER CODE</b>	<b>WALL TYPE</b>
		SF2LOK05FB	Slatwall Adjustable Program Minimum quantity: 2000 <i>See page 28 for Fastbak BakPak™ Spacers</i>
		<b>SH500 FLEXIBLE LOCKING HOOK – DOUBLE WIRE – 9” (23 MM)</b>	
		<b>ORDER CODE</b>	<b>WALL TYPE</b>
		SF2LOK01	American Pegboard
		<b>SH500 FLEXIBLE LOCKING HOOK – DOUBLE WIRE – 9” (23 CM)</b>	
		<b>ORDER CODE</b>	<b>WALL TYPE</b>
		SF2LOK01E	European Pegboard Minimum quantity: 2000
		<b>SH500 FLEXIBLE LOCKING HOOK – DOUBLE WIRE FASTBAK™ – 9” (23 CM)</b>	
		<b>ORDER CODE</b>	<b>WALL TYPE</b>
		SF2LOK01FB	Slatwall Adjustable Program <i>See page 28 for Fastbak BakPak™ Spacers</i>

Minimum Order is 25 unless otherwise stated above

# Flexible Locking Hook – Single Wire

Allows retailers to select the number of “live” and “locked” merchandise items.



**FLEXIBLE HOOK - SINGLE WIRE ORDERING INFORMATION**



**FLEXIBLE LOCKING SINGLE WIRE HOOK - 5.50" (14 CM)**

ORDER CODE	WALL TYPE
------------	-----------

SFLOK15S	American Pegboard
SFLOK15E	European Pegboard



**FLEXIBLE LOCKING SINGLE WIRE HOOK - 5.50" (14 CM)**

ORDER CODE	WALL TYPE
------------	-----------

SFLOK15F	Flat Bar - For use with .2" x 1" (5mm x 26mm) bar
----------	---



**FLEXIBLE LOCKING SINGLE WIRE HOOK - 7.75" (20 CM)**

ORDER CODE	WALL TYPE
------------	-----------

SFLOK16F	Flat Bar - For use with .2" x 1" (5mm x 26mm) bar
----------	---

# Locking Hook

The Locking Hook allows retailers to enjoy the security of locked cabinets with the sales benefits of open merchandising.



## LOCKING HOOK ORDERING INFORMATION



### SH500 LOCKING HOOK – 7” (18 CM)

ORDER CODE	WALL TYPE
SFL05	American Pegboard
SFL05E	European Pegboard



### SH500 LOCKING HOOK – FASTBAK™ – 7” (18 CM)

ORDER CODE	WALL TYPE
SFL05FB	Slatwall Adjustable Program



### OM LOCKING HOOK – HANG BAR – 7” (18 CM)

ORDER CODE	WALL TYPE
SFL05BAR1	Designed to fit 0.5” – 1.5” (12.7 mm x 38 mm) bar



### SH500 LOCKING HOOK – 9” (23 CM)

ORDER CODE	WALL TYPE
SFL01	American Pegboard
SFL01E	European Pegboard



### SH500 LOCKING HOOK – FASTBAK™ – 9” (23 CM)

ORDER CODE	WALL TYPE
SFL01FB	Slatwall Adjustable Program



### SH500 LOCKING HOOK – 9” (23 CM)

ORDER CODE	WALL TYPE
SFL01G2	Wire Grid #2 Minimum quantity: 2000



### SH500 LOCKING HOOK – HEAVY DUTY – 9” (23 CM)

ORDER CODE	WALL TYPE
SFL01H	American Pegboard



### SH500 LOCKING HOOK – 11” (28 CM)

ORDER CODE	WALL TYPE
SFL04	American Pegboard



### SH500 LOCKING HOOK – 12” (30CM)

ORDER CODE	WALL TYPE
SFL03	American Pegboard



### SH600 LOCKING HOOK – 3-WIRE – 12” (30 CM)

ORDER CODE	WALL TYPE
SFL30E	European Pegboard Minimum quantity: 2000

Minimum Order is 25 unless otherwise stated above



## OM KEY

InVue's OM Key provides an easy-to-use key for use with Secure Fixtures. The unique shape and proprietary magnetics differentiate it from other magnet locking solutions.

### LOCKING HOOK ORDERING INFORMATION



#### OM KEY AM ON RECOILER

ORDER CODE	WALL TYPE
SFKEYNDRL	SH500 Series, StopLok™, Helix™

#### OM KEY RF ON RECOILER

ORDER CODE	WALL TYPE
SFKEYRFRL	SH500 Series, StopLok™, Helix™

## OM REMOVAL TOOL

The OM Removal Tool is designed for “on-floor” associate use of the OM Key.

### LOCKING HOOK ORDERING INFORMATION



#### OM REMOVAL TOOL

ORDER CODE	WALL TYPE
OM-RT	SH500 Series, StopLok™, Helix™

# Secure Fixtures Accessories



Bracket on Bar



Bracket on Grid



IR Locking Hook  
affixed to bracket

## ORDER CODE

## DESCRIPTION



SFBP01

Secure Hook Grid/Bar Adapter  
Designed to fit 0.5" x 1" (12.7 mm x 25.4 mm) bar  
For use with Bar, Grid and Standard American Prong Hooks



SFBP02

Secure Hook Grid/Bar Adapter  
Designed to fit 0.5" x 1.2" (12.7 mm x 30.5 mm) bar  
For use with Bar, Grid and Standard American Prong Hook



SFBP03

Secure Hook Grid/Bar Adapter  
Designed to fit 0.2" x 1" (5.1 mm x 25.4 mm) bar  
For use with Flat Bar, Grid and Standard European Prong Hooks



SHT

Open Face Tag  
1.8" (45.7 mm)  
Fits standard tag holders



SHTA002

Open Face Tag  
3.4" (86.3 mm)  
Fits standard tag holders



SHTA003

Open Face Tag  
2.6" (66 mm)  
Fits standard tag holders



SHT-2.25-25

Closed Face Tag  
2.25" (57.1 mm)



SHT-2.50-25

Closed Face Tag  
2.5" (63.5 mm)



NLAP01

Lock Symbol Tag  
For use with IR Locking Hooks™



SFAP02

"Locked Merchandise See Sales Associate" Tag, for use  
with SH500 Locking Hooks,  
Minimum Order: 2000



SFAP02-SYM

Lock Symbol Tag, for use with SH500 Locking Hooks  
Minimum Order: 2000

Minimum Order: 25 units per order code

# FastBak Spacers™

## FASTBAK FOR SLATWALL

Board Material: Wood  
 Channel Insert: Metal, Plastic or None

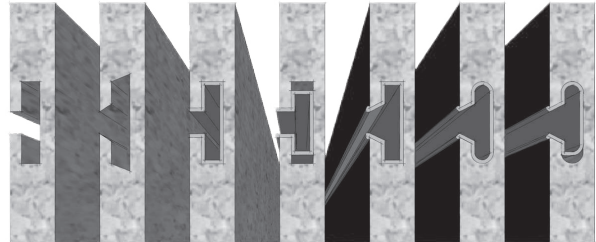





Non-standard Slatwall Configurations



“Standard” slatwalls can vary greatly. To address these variations, InVue created the Fastbak program. By using a system of configurable plastic spacers, we create a customized solution to ensure a tight and secure fit.

Please see your sales representative for more information about customizing your slatwall fit.

### FASTBAK SPACERS

ORDER CODE	DESCRIPTION
 BPMW	Spacer – White Metal Hole Location
 BPMB	Spacer – Black Metal Hole Location
 BPPW	Spacer – White Plastic Hole Location
 BPPB	Spacer – Black Plastic Hole Location

Minimum Order: 200 units per order code

# Wallboard Reference Information

## AMERICAN PEGBOARD

Material: Wood  
 Pegboard Thickness: 0.22" (5.6 mm)

Note: The American Pegboard tolerance range is broad. Check for an American Pegboard hook on your wall first.

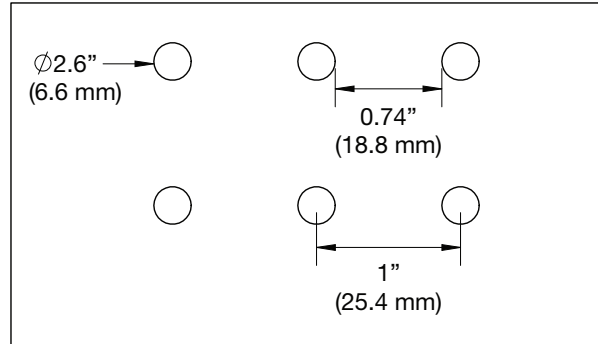

## EUROPEAN PEGBOARD (TEGO-STYLE)

Material: Thin Wall Metal  
 Pegboard Thickness: 0.06" (1.6 mm)

Note: Many European Pegboard applications will use the Australian Pegboard hooks, and many Australian Pegboard applications will use the European Pegboard hooks. Check both options for a fit.

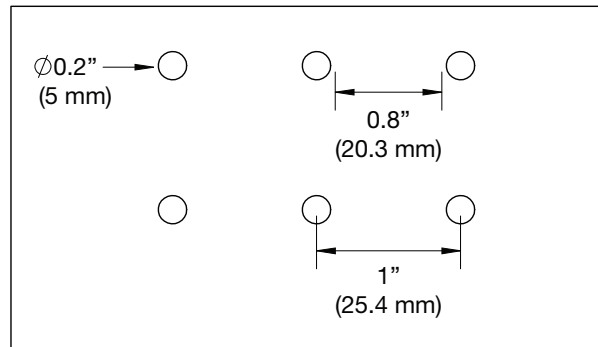

## WIRE GRID 1

Material: Wire  
 Wire Diameter: 0.25" (6.35 mm)

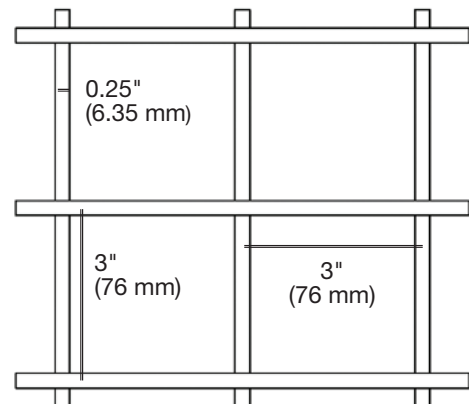

## WIRE GRID 2

Material: Metal Wire  
 Diameter of Wires: 0.26" (6.53 mm)

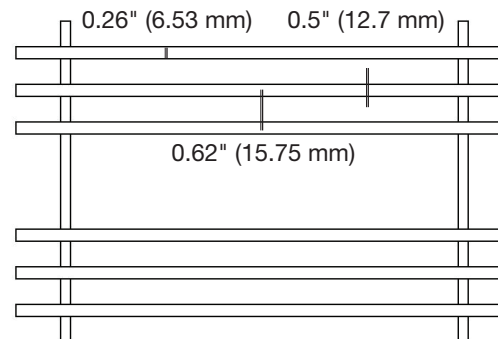



[www.invue.com](http://www.invue.com)

**The Americas** 704.752.6513 • 888.55.INVUE  
**Europe, Middle East, and Africa** +31.23.8900150  
**Asia Pacific** +852.3127.6811